



KIESELMANN

FLUID PROCESS GROUP

Translation of the original

Operating Instructions

Straight-way ball valve

pneumatic und manual operation

Types 402x

412x

422x



KIESELMANN GmbH

Paul-Kieselmann-Str. 4-10
D - 75438 Knittlingen

 +49(0) 7043 371-0 •  +49(0) 7043 371-125
www.kieselmann.de • info@kieselmann.de

Copyright: © KIESELMANN FLUID PROCESS GROUP

Table of contents

1	General informations	4
1.1	Informations for your safety	4
1.2	Marking of security instructions	4
1.3	General designated use	4
1.4	Personnel	4
1.5	Modifications, spare parts, accessories	5
1.6	General instructions	5
2	Safety instructions	6
2.1	Intended use	6
2.2	General notes	6
2.3	General safety instructions	6
3	Delivery, transport and storage	8
3.1	Delivery	8
3.2	Transport	8
3.3	Storage	8
4	Specification	9
4.1	Modular system	9
5	Function and operation	10
5.1	Description of function	10
5.2	Control system and position indication	11
6	Commissioning, service and maintenance	12
6.1	Commissioning	12
6.1.1	Installation instructions	12
6.1.2	General welding guidelines	12
6.1.3	Use in EX area	12
6.2	Service	13
6.3	Cleaning	13
7	Technical data	14
8	Disassembly and assembly	15
8.1	Disassembly	15
8.2	Assembly	16
9	Drawings and dimensions	17
9.1	Control units	17
9.2	Drawings	18
9.3	Dimensions	19
10	Wearing parts	20
10.1	Wear parts kit	20
10.2	Spare parts list	21
11	Classification	22
11.1	Structure of Order Number	22
12	Appendix	24
12.1	Declaration of incorporation	24

1 General informations

1.1 Informations for your safety

We are pleased that you have decided for a high-class KIESELMANN product. With correct application and adequate maintenance, our products provide long time and reliable operation.





Before installation and initiation, please carefully read this instruction manual and the security advices contained in it. This guarantees reliable and safe operation of this product and your plant respectively. Please note that an incorrect application of the process components may lead to great material damages and personal injury.

In case of damages caused by non observance of this instruction manual, incorrect initiation, handling or external interference, guarantee and warranty will lapse!

Our products are produced, mounted and tested with high diligence. However, if there is still a reason for complaint, we will naturally try to give you entire satisfaction within the scope of our warranty. We will be at your disposal also after expiration of the warranty. In addition, you will also find all necessary instructions and spare part data for maintenance in this instruction manual. If you don't want to carry out the maintenance by yourself, our KIESELMANN - service team will naturally be at your disposal.

1.2 Marking of security instructions

Hints are available in the chapter "safety instructions" or directly before the respective operation instruction. The hints are highlighted with a danger symbol and a signal word. Texts beside these symbols have to be read and adhered to by all means. Please continue with the text and with the handling at the valve only afterwards.

Symbol	Signal word	Meaning
	DANGER	Imminent danger which will result severe personal injury or death.
	WARNING	Imminent danger which may result severe personal injury or death.
	CAUTION	Dangerous situation which may cause slight personal injury or material damages.
	NOTICE	An harmful situation which may result in damages of the product itself or of adjacent vicinity.
	INFORMATION	Marks application hints and other information which is particularly useful.

1.3 General designated use

The fitting is designed exclusively for the purposes described below. Using the fitting for purposes other than those mentioned is considered contrary to its designated use. KIESELMANN cannot be held liable for any damage resulting from such use. The risk of such misuse lies entirely with the user. The prerequisite for the reliable and safe operation of the fitting is proper transportation and storage as well as competent installation and assembly. Operating the fitting within the limits of its designated use also involves observing the operating, inspection and maintenance instructions.

1.4 Personnel

Personnel entrusted with the operation and maintenance of the tank safety system must have the suitable qualification to carry out their tasks. They must be informed about possible dangers and must understand and observe the safety instructions given in the relevant manual. Only allow qualified personnel to make electrical connections.

1.5 Modifications, spare parts, accessories

Unauthorized modifications, additions or conversions which affect the safety of the fitting are not permitted. Safety devices must not be bypassed, removed or made inactive. Only use original spare parts and accessories recommended by the manufacturer.

1.6 General instructions

The user is obliged to operate the fitting only when it is in good working order. In addition to the instructions given in the operating manual, please observe the relevant accident prevention regulations, generally accepted safety regulations, regulations effective in the country of installation, working and safety instructions effective in the user's plant.

2 Safety instructions

2.1 Intended use

Straight-way ball valves are used as a shut-off valve in units of the beverage and food industry, the pharmacy, the biotechnology as well as the chemical industry.

2.2 General notes



NOTICE - observe the operating instructions

To avoid danger and damage, the fitting must be used in accordance with the safety instructions and technical data contained in the operating instructions.



NOTICE

All data are in line with the current state of development. Subject to change as a result of technical progress.

2.3 General safety instructions



⚠ WARNING

Risk of injury by outflowing medium

Dismantling the valve or valve assemblies from the plant can cause injuries.

- Medias flowing through the leakage drain outlet are to be drained off without splashing into a discharge arrangement.
- Carry the disassembling only if when the plant has been rendered pressure-less and free of liquid and gas.



⚠ WARNING

Risk of injury by moving parts

Do not grab into the valve when the actuator is pressurized. Limbs can be crushing or amputating.

- Remove the control air line before dismantling.
- Ensure that the actuator is unpressurized.



⚠ WARNING

Risk of injury by pre-stressed pressure spring.

The pneumatic-mechanical actuator is spring-loaded. When disassembling the actuator, components that jump out may cause injuries.

- Multiturn actuator are maintenance-free and therefore do not need to be opened!



⚠ WARNING

ATEX - Guidelines

If the valve or the plant is operated in a potentially explosive atmosphere, the valid ATEX directive of the EC and the installation instructions in this operating manual must be observed.



⚠ CAUTION

To avoid air leaking, only use pneumatic connection parts that have an O-ring seal facing the even surface.



⚠ CAUTION

Before starting the system, the entire pipeline system must be thoroughly cleaned.



 **CAUTION**

Steps should be taken to ensure that no external forces are exerted on the fitting.

3 Delivery, transport and storage

3.1 Delivery

- Immediately after receipt check the delivery for completeness and transport damages.
- Remove the packaging from the product.
- Retain packaging material, or expose of according to local regulations.

3.2 Transport



CAUTION

Risk of injury and damage to the product

During the transport the generally acknowledged rules of technology, the national accident prevention regulations and company internal work and safety regulations must be observed.

3.3 Storage



NOTICE

Damage to the product due to improper storage!

Observe storage instructions
avoid a prolonged storage



INFORMATION













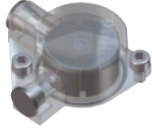





Recommendation for longer storage

We recommend regularly checking the product and the prevailing storage conditions during long storage times.

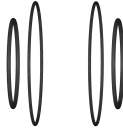
- To avoid damage to seals and bearings,
 - products up to DN 125 / OD 5 inch should be stored horizontally for maximum 6 months.
 - products larger than DN 125 / 5 inch, should be stored in the upright position with the actuator on top.
- Don't store any objects on the products.
- Protect the products for wetness, dust and dirt.
- The product should be stored in a dry and well ventilated room at a constant temperature (optimal indoor temperature: 25 C ±5 ; indoor humidity data 70% ±5%).
- Protect seals, bearings and plastic parts for UV light and ozone.

4 Specification

4.1 Modular system

KI-Top control head		Feedback unit		
				
Stainless steel hood:	Transparent hood			
drive systems				
pneumatical			electrical	
PDA 90/75 Ø 75	PDA 90/100 Ø 100	PDA 90/125 Ø 125	4040	
				
manual				
Hand lever	Hand lever with sensor mounting	Hand lever stainless steel	Hand lever continuously adjustable	
				
Model				
Standard PTFE - Thrust collar		Filling element PTFE - shell		
				
Seal material				
			EPDM NBR FKM VMQ	
connection flanges				
S	G	K/M	FI	CI
				

5 Function and operation

5.1 Description of function

Straight-way ball cocks are used as a piggable shut-off valve.

Open or close the valve by turning the pneum. controlled rotary drive by 90°.

Functional description for valves with manual operation

When actuating a fitting manually, the respective switching position will be locked in place in the final position. Before operation, unlock the final position lock by lifting the notch lever against the hand lever. By letting go of the notch lever in the respective final position the spring-loaded notch lever will latch back by itself to the final position lock. The position of the hand lever indicates whether the valve is opened or closed. It will be opened, if the valve points in the direction of the pipe axle – it will be closed, if the valve is positioned crosswise to the pipe axle. The possible assembly-line ways in dependence of the stop functions linked with it are shown in the as valve positions.

Valve positions

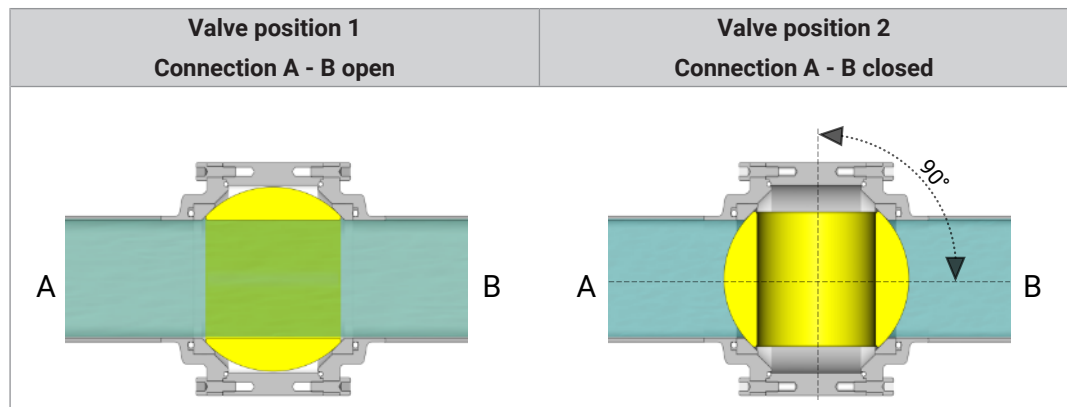

Functional description for valves with pneumatic operation

The valve opens and closes by way of a pneum. multiturn actuator with a rotary movement of 90°.

normal closed (NC)

- pneum. OPERATED opens the valve
- not pneum. OPERATED spring force closes the valve

normal open (NO)

- pneum. OPERATED closes the valve
- not pneum. OPERATED spring force opens the valve

double acting (DA)

- pneum. OPERATED the valve opens or closes according to control

5.2 Control system and position indication

Retrofitting to end position feedback for manually operated valves

By replacing the hand lever and the catch disc the valve can be retrofitted for end position feedback (proximity switch).

Conversion from manual operation to pneumatic actuation

By a simple retrofitting operation the valve can be converted to pneumatic actuation. The rotary actuator for this purpose is supplied complete with fitting device. The following actuators are available, depending on the desired actuating function.

Nominal size	Drive	air open - air close (DA)	Normally closed (NC)
DN25 - DN80	PDA 90/100	4100 080 100-022	4200 080 100-022
DN 100	PDA 90/125	4100 100 125-022	4200 100 125-022

Nominal size	Drive	air open - air close (DA)	Normally closed (NC)
OD 1" - 3"	PDA 90/100	4100 080 100-022	4200 080 100-022
OD 4"	PDA 90/125	4100 100 125-022	4200 100 125-022

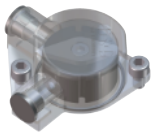

Position indicator with sensor mounting for feedback signal.

The actuator is equipped with a proximity switch mounting (sensor mounting) and a position indication. When inductive proximity initiators M 12x1 are installed, the current "Open" or "Shut" position can be interrogated. By screwing the proximity initiator to the limit position the required switching gap for the signal transmission is established. When the valve is closed the position indication is oriented vertically to the direction of valve passage. When the valve is open it is oriented parallel to the valve passage.



Feedback unit -optional-

Optionally, modular valve control head systems can be installed to the actuator for reading and actuating valve positions. The standard version is a closed system with SPS or ASI-bus switch-on electronics, and integrated 3/2-way solenoid valves. For tough operating conditions we recommend employing a high-grade steel cover.

6 Commissioning, service and maintenance

6.1 Commissioning

6.1.1 Installation instructions

For ball valves without leakage outlet, the installation position is without importance.

Ball valves with leakage outlet must always be installed vertically to ensure that outflow of leakage, or of cleaning medium, from the valve is such that no residue will remain inside the valve.

For valves which are to be welded in on both sides, a releasable connection has to be fitted into the pipework to allow dismounting (maintenance).

6.1.2 General welding guidelines

Sealing elements integrated in weld components must generally be removed prior to welding. To prevent damage, welding should be undertaken by certified personnel (EN ISO 9606-1). Use the TIG (Tungsten Inert Gas) welding process.



CAUTION

Damage and injuries due to high temperature supply

To avoid a distortion of the components, all welding parts must be welded to stress-relieved.

Allow all components to cool before assembling.



NOTICE

Damage due to impurities

Impurities can cause damage to the seals and seals area.

Clean inside areas prior to assembly.

6.1.3 Use in EX area

For valves or plants/installations that are operated in the ATEX area, sufficient bonding (grounding) must be ensured. (see e.g. ATEX Directives EC; UKSI 696:2019-Schedule 25)

6.2 Service



RECOMMENDATION

Replacement of seals

To achieve optimal maintenance cycles, the following points must be observed!

- When replacement of seals, all product-contacting seals should be replaced.
- Only original spare parts may be installed.

Maintenance interval

The maintenance intervals depend on the operating conditions "temperature, temperature-intervals, medium, cleaning medium, pressure and opening frequency". We recommend replacing the seals 2-year cycle. The user, however should establish appropriate maintenance intervals according to the condition of the seals.

Lubricant recommendation

	EPDM; HNBR; NBR; FKM; k-flex	- Klüber Paraliq GTE703*
	Silicone	- Klüber Sintheso pro AA2*
	Thread	- Interflon Food*
*) It is only permitted to use approved lubricants, if the respective fitting is used for the production of food or drink. Please observe the relevant safety data sheets of the manufacturers of lubricants.		

6.3 Cleaning

In order to ensure continuous flawless function during operation, the surfaces between the valve body and the ball must be cleaned.

Open and close the valve several times from the open position. With an angle of rotation of $\geq 20^\circ$, cleaning fluid flows into the area between the ball and casing. A time-dependent actuation in the angle of rotation range 20° - 45° makes the cleaning process more efficient. The duration and the number of actuations should be adjusted according to the type of dirtying and the degree of dirtying.

7 Technical data

Model	Straight-way ball valve	
Size	DIN: DN 25 - DN 100 Inch: DN 1" - DN 4"	
Connection type	Welding end (S) DIN EN 10357 Thread (G) DIN 11851 Flange (FI) Clamp (CI) Liner/nut (K/M) DIN 11851	
Temperature range	Ambient temperature: (air)	+4° to +45°C
	Operating temperature: (depends on medium)	+0° to +95°C
	Sterilisation temperature: (SIP 30 min)	EPDM +140°C PTFE +130°C NBR +100°C FKM +140°C VMQ +90°C
Operating pressure	16 bar	
Cleaning pressure	3 bar	
Leakage rate	A (DIN EN 12266-1)	
Control air	Control air pressure: 5,5 - 8,0 bar	Control air quality: ISO 8573-1 : 2001 quality class 3
Material (in contact with product)	Stainless steel:	1.4404 / AISI 316L 1.4301 / AISI 304
	Surface:	Ra ≤ 0,8µm, e-polished
	Sealing material:	EPDM / PTFE NBR / PTFE FKM / PTFE VMQ / PTFE

8 Disassembly and assembly

8.1 Disassembly



NOTICE

All threaded joint have right-hand thread.

Unscrew and remove control air, steam resp. cleaning lines and electrical lines, complete feedback unit or control head.

Remove the ball valve completely from the housing.

Replacing the housing seals (12), (13), (14)

- Unscrew the flange (2).
- Dismantle the O-rings (13), (14) and thrust collar (12).
- Put the ball cock in the closed position and remove the ball (3) out of the housing (1).

Ball valve manual operation - Replacing the sealing package (6) - (10)

- Unscrew the screw (18) and remove the hand lever (19).
- Unscrew the screw (16) and remove the locking disc (5).
- Remove the plain bearing (10) and the pressure spring (11) from the axis (4).
- Dismantle the axis (4) with sliding ring (6) out of the housing (1) downwards.
- Take the sealing package (7/8/9) out of the housing (1).

Ball valve - pneum. operation - Replacing the sealing package (6) - (10)

- Unscrew the screws (20) and remove the pneum. actuator (24) with the square boss (23).
- Unscrew the screws (22) and remove the angle bracket (21).
- Remove the plain bearing (10) and the pressure spring (11) from the axis (4).
- Dismantle the axis (4) with sliding ring (6) out of the housing (1) downwards.
- Take the sealing package (7/8/9) out of the housing (1).

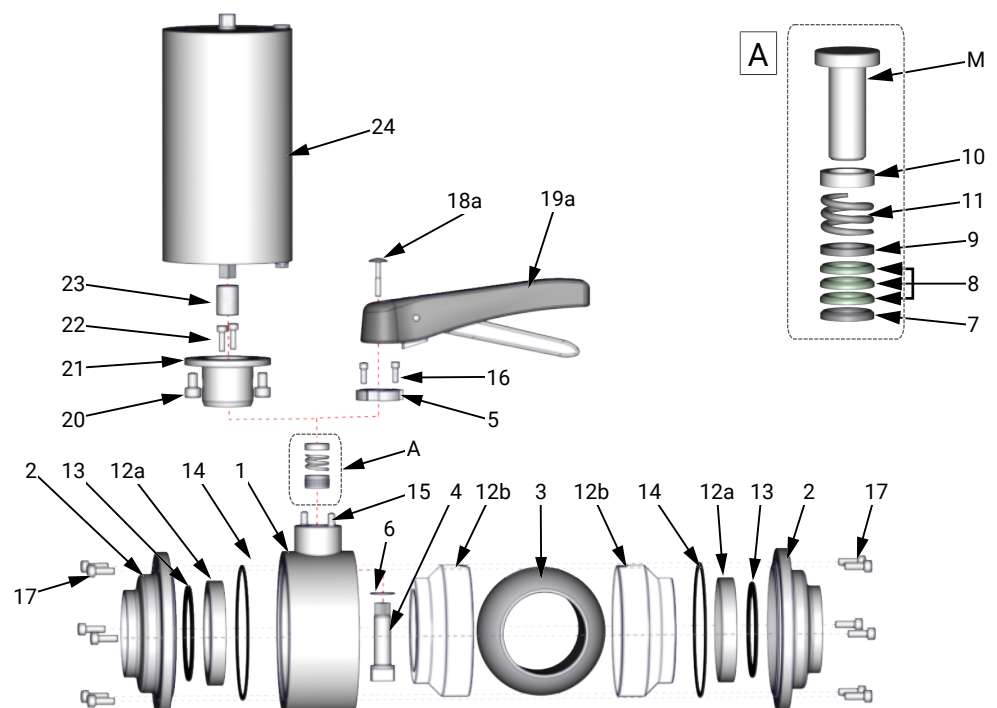

8.2 Assembly

- Before installation, thoroughly clean and slightly lubricate mounting areas and running surfaces.
- Assemble in reverse order.



NOTICE

Instructions d'installation

Mount the sealing package (7/8/9) in the sequence shown under view.

b) Push the bearing ring (7), the V-rings (8) (3x) and the thrust collar (9) with the mounting sleeve (M) into the limit stop.

c) When mounting the ball (3) and the axis (4), regards for exact match from the marks on the axis (4) and the position of the ball (3).

d) The mark points (MP) on the switch axis correspond to the respective ball openings.

e) Mount the hand lever or the pneumatic actuator according of the valve functions.

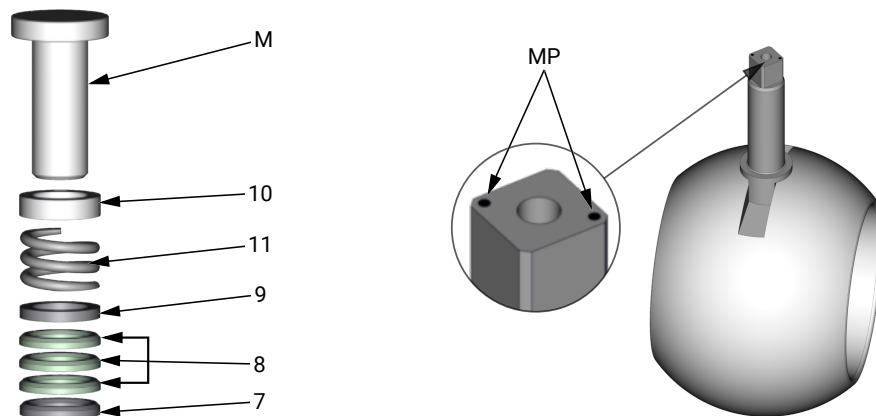

9 Drawings and dimensions

9.1 Control units

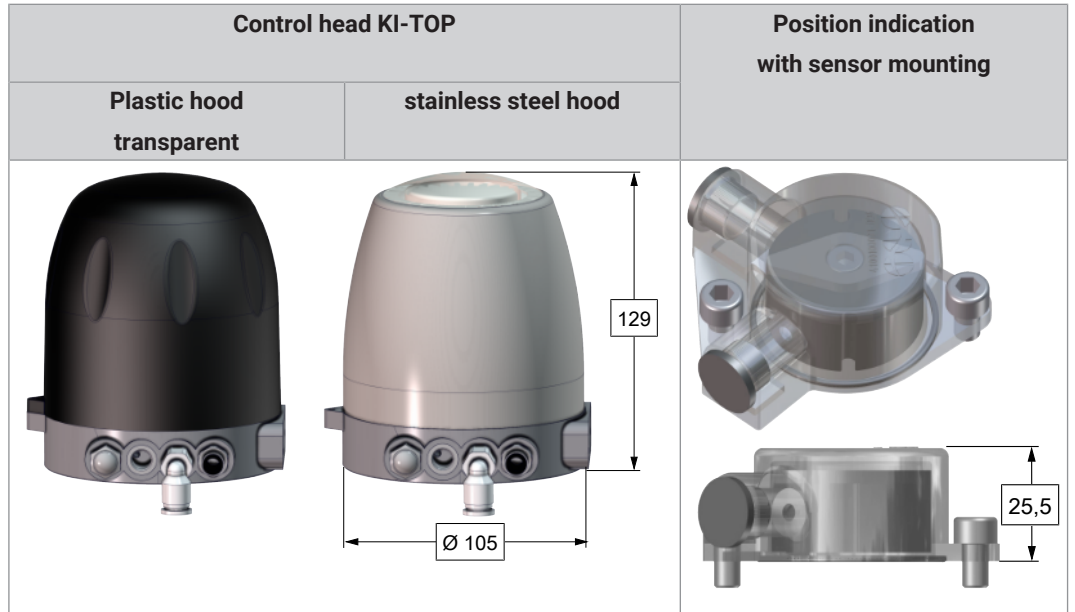

Position indication with sensor mounting (R)

- R1 = dog
- R1.1 = Straight pin
- R2 = Position indication
- R3 = O-ring
- R4 = Screw
- R5 = Sensor mounting
- R6 = Cap
- R7 = Screw

- LA = air supply

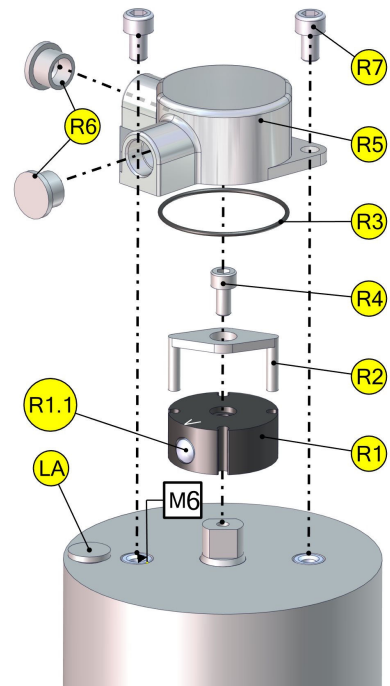

9.2 Drawings

- Example: ball cock with welding end (Standard version)

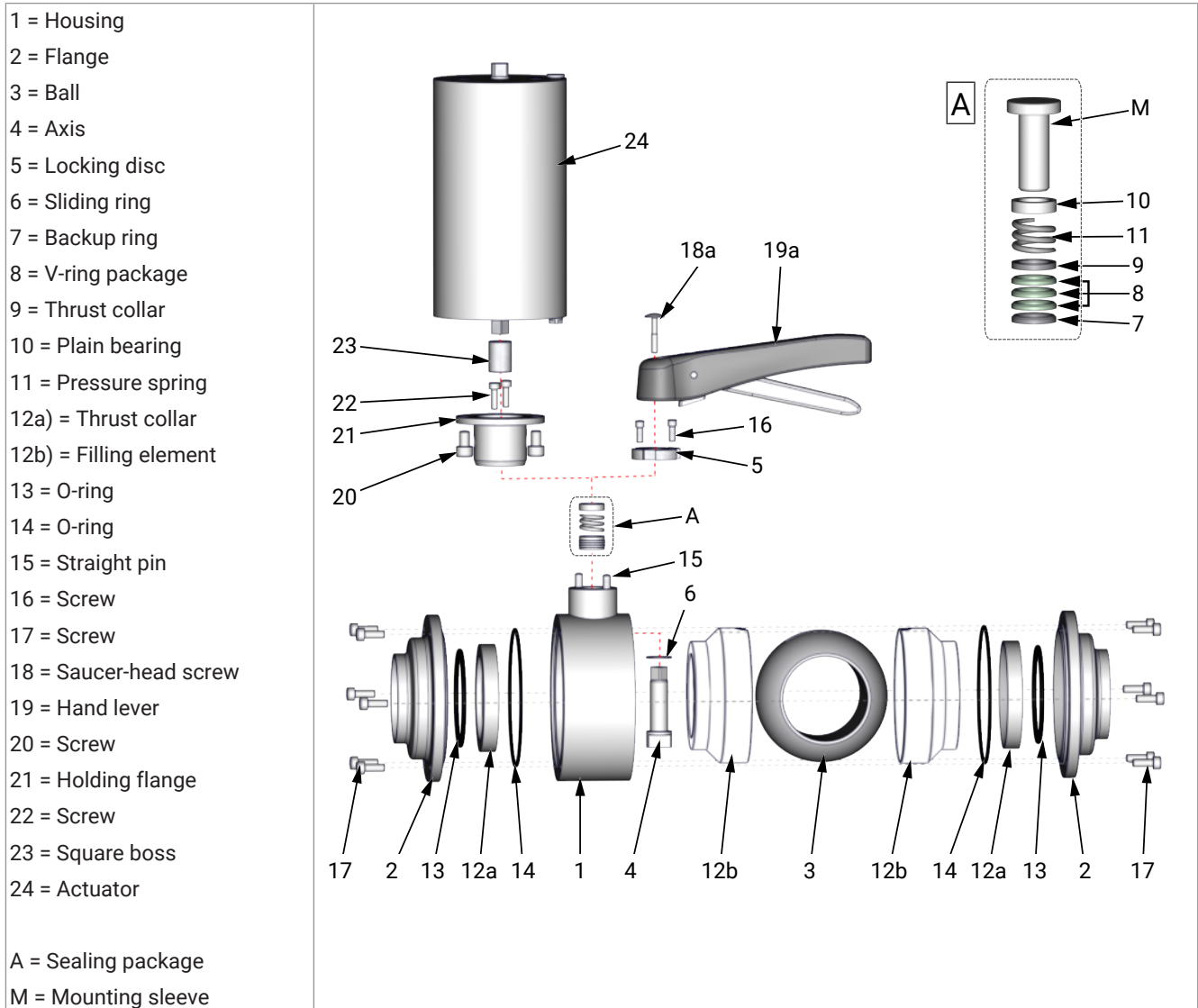

9.3 Dimensions

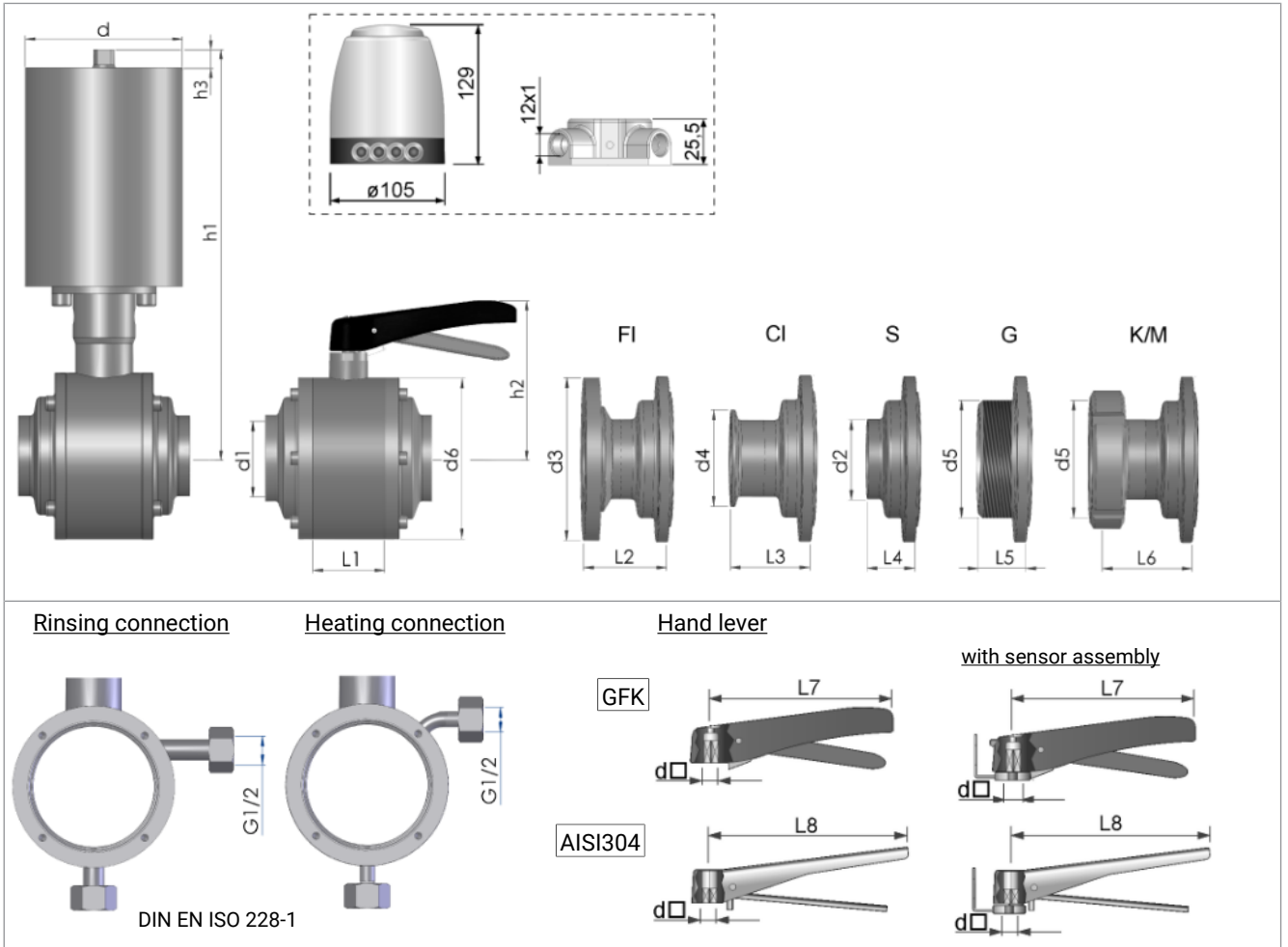

DN	d	d1	d2	d3	d4	d5	d6	d \blacksquare	h1	h2	h3	L1	L2	L3	L4	L5	L6	L7	L8
25	104	26	29	80	50.5	Rd52x1/6	74	10	307	117	13	34	53.5	51	29.5	29.5	51.5	165	180
32	104	32	35	86	50.5	Rd58x1/6	85	10	311	121	13	38	55.5	53	31.5	31.5	56.5	165	180
40	104	38	41	92	50.5	Rd65x1/6	95	10	315	125	13	40	55.5	53	31.5	31.5	57.5	165	180
50	104	50	53	108	64	Rd78x1/6	110	10	324	134	13	50	55.5	53	31.5	31.5	59.5	165	180
65	104	66	70	130	91	Rd95x1/6	130	10	335	145	13	56	58.5	62.5	34.5	34.5	66.5	165	180
80	104	81	85	146	106	Rd110x1/4	159	14	346	156	13	70	70.5	74.5	46.5	46.5	83.5	-	285
100	129	100	104	166	119	Rd130x1/4	195	14	412	206	20	100	84	88	60	50	104	-	285

DN	d	d1	d2	d3	d4	d5	d6	d \blacksquare	h1	h2	h3	L1	L2	L3	L4	L5	L6	L7	L8
1"	104	22.1	29	80	50.5	Rd52x1/6	74	10	307	117	13	34	53.5	51	29.5	29.5	51.5	165	180
1½"	104	34.8	41	92	50.5	Rd65x1/6	95	10	315	125	13	40	55.5	53	31.5	31.5	57.5	165	180
2"	104	47.5	53	108	64	Rd78x1/6	110	10	324	134	13	50	55.5	53	31.5	31.5	59.5	165	180
2½"	104	60.2	70	130	91	Rd95x1/6	130	10	335	145	13	56	58.5	62.5	34.5	34.5	66.5	165	180
3"	104	72.1	85	146	106	Rd110x1/4	159	14	346	156	13	70	70.5	74.5	46.5	46.5	83.5	-	285
4"	129	97.6	104	166	119	Rd130x1/4	195	14	412	206	20	100	84	88	60	50	104	-	285

10 Wearing parts

10.1 Wear parts kit

Wear parts kit complete			
- Seal kit - in product contact Pos. (12), (13), (14)			
- Seal kit - switch axis Pos. (6) - (10)			
- Mounting sleeve Pos. (M)			
Nominal size	NBR / PTFE	EPDM / PTFE	VITON / PTFE
DN 25 - 100	4084 DN 000-055	4084 DN 000-000	4084 DN 000-051
OD 1" - 4"	4084 OD 000-055	4084 OD 000-000	4084 OD 000-051

- Seal kit - in product contact Pos. (12), (13), (14)			
Nominal size	NBR/PTFE	EPDM/PTFE	VITON/PTFE
DN 25 - 100	4084 DN 010-055	4084 DN 010-000	4084 DN 010-051
OD 1" - 4"	4084 DN 010-055	4084 DN 010-000	4084 DN 010-051

*) **DN** = Nominal diameter e.g. 4084 **050** 000-055

*) **OD** = Nominal diameter e.g. 4084 **051** 000-055

Seal kit switch axis Pos. (6)-(10), (M)	
Nominal size	
DN 25 - 80	4084 080 020-000
DN 100	4084 100 020-000
OD 1" - 3½"	4084 080 020-000
OD 4"	4084 100 020-000

Mounting sleeve Pos. (M)	
Nominal size	
DN 25 - 80	4084 080 021-057
DN 100	4084 100 021-057
OD 1" - 3½"	4084 080 021-057
OD 4"	4084 100 021-057

10.2 Spare parts list

Item	Designation	Material
1	Housing	1.4301 / 1.4404
2	Flanges Welding flange (S) - Male flange (G) - Small flange (FI) - Clamp flange (CI) - Liner/nut - flange (K/M)	1.4301 / 1.4404
3	ball	1.4301 / 1.4404
4	axis	1.4301 / 1.4404
5	locking disc	1.4308
6	sliding ring	PTFE
7	Backup ring	PTFE
8	V-ring package	PTFE
9	Thrust collar	PTFE
10	Slide bearing	PTFE
11	Pressure spring	1.4310
12	Model a) Standard = Thrust collar b) Filling element	PTFE PTFE
13	O-ring	NBR, EPDM, FKM
14	O-ring	NBR, EPDM, FKM
15	Straight pin DIN7	1.4301
16	Screw DIN912	1.4301
17	Screw DIN912	1.4301
18	a) Saucer-head screw b) Screw DIN912	1.4301 1.4301
19	Hand lever a) Standard b) Stainless steel	GFK 1.4301
20	Screw DIN912	1.4301
21	Holding flange	1.4301
22	Screw DIN912	1.4301
23	Square boss	1.4301
24	Actuator: - (air / spring) - (air / air)	1.4301 1.4301

11 Classification

11.1 Structure of Order Number

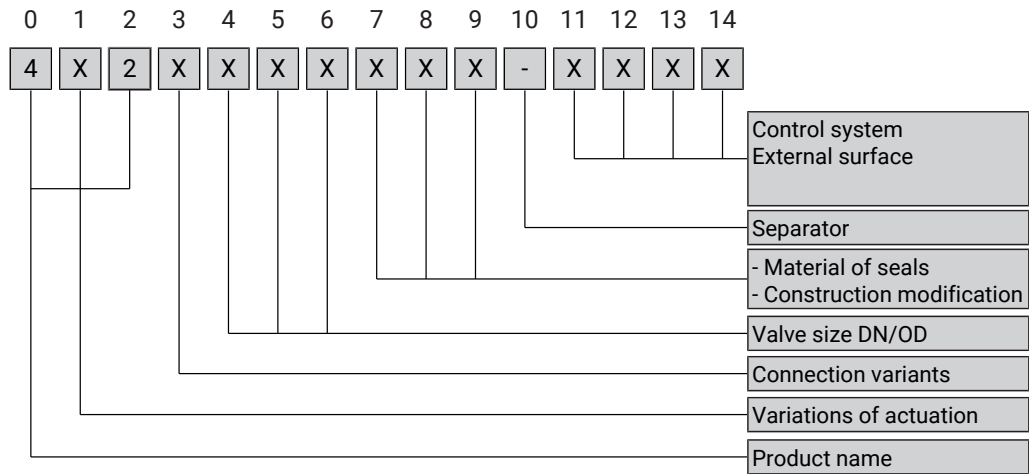

Product name

4x2x xxx xxx-xxx			
Product name	Pos. 0	Pos. 1	Pos. 2
Straight-way ball valve	4	x	2

e.g. Type 4225 - Straight way ball cock pneumatic operation, air open - spring close, with weld flange

drive systems

xXxx xxx xxx-xxx	
drive systems	Pos. 1
Manual drive	0
Actuator pneumatic (air / air)	1
Actuator pneumatic (air / spring)	2

Connection type

xxxX xxx xxx-xxx				
Combination of flange connection	Pos. 3	Pos. 7	Pos. 8	Pos. 9
(G - G) Thread - Thread	1			
(K/M - G) Liner/nut - thread	2			
(S - S) Welding end - Welding end	5			
(G - S) Thread - Welding end [EPDM]	1	1	7	0

Valve size

xxxx XXX xxx-xxxx								
Nominal diameter	Pos. 4	Pos. 5	Pos. 6		Nominal diameter	Pos. 4	Pos. 5	Pos. 6
DN 25	0	2	5		DN 80	0	8	0
DN 40	0	4	0		DN 100	1	0	0
DN 50	0	5	0		DN 125	1	2	5
DN 65	0	6	5		DN 150	1	5	0
OD 1"	0	2	6		OD 3 "	0	7	6
OD 1 1/2"	0	3	8		OD 4 "	1	0	1
OD 2 "	0	5	1		OD 5"	1	2	7
OD 2 1/2"	0	6	4		OD 6 "	1	5	2

Material of seal / Design modification

xxxx xxx XXX -xxx	
Sealing material in product contact:	EPDM; NBR; FKM; VMQ
Design modification:	Filling element; heatable; flushable

Separator

xxxx xxx xxx - xxxx	Pos. 10
- Standard	-

Control system, position indicator, surfaces

xxxx xxx xxx- XXXX	Pos. 11	Pos. 12	Pos. 13	Pos. 14
Valve with feedback unit, External surface AISI304 blank	0	2	0	
Valve with feedback unit, External surface AISI316L blank	0	4	0	
Valve with feedback unit, External surface AISI304 E-polished	0	2	1	
Valve with feedback unit, External surface AISI316L, E-polished	0	4	1	
Valve with feedback unit, External surface AISI304 blasted	0	2	2	
Valve with feedback unit, External surface AISI316L blasted	0	4	2	
Control head KI-Top SPS	K	5	x	x
Control head KI-Top ASi-Bus	K	6	x	x

12 Appendix

12.1 Declaration of incorporation



Declaration of incorporation

Translation of the original

Manufacturer / authorised representative:

KIESELMANN GmbH

Paul-Kieselmann-Str. 4-10

75438 Knittlingen

Germany

Authorised representative:

(for compiling technical documents)

Achim Kauselmann

(Documentation / Development)

KIESELMANN GmbH

Paul-Kieselmann-Str. 4-10

75438 Knittlingen

Germany

<u>Product name</u>	<u>Function</u>
pneum. Lift actuators	Stroke movement
pneum. Rotary actuators	Rotary movement
Ball valves	Media cutoff
Butterfly valves	Media cutoff
Single seat valves	Media cutoff
Flow control valves	Control of liquefied media
Throttle valve	Control of liquefied media
Overflow valve	Definition of fluid pressure
Double seat valve	Media separation
Bellow valves	Sampling of liquids
Sampling valves	Sampling of liquids
Two way valves	Media cutoff
Tankdome fitting	Prevention of overpressure and vacuum, Tank cleaning
Safety valve	Prevention of overpressure

The manufacturer hereby states that the above product is considered as an incomplete machine in the sense defined in the Directive 2006/42/EC on Machinery. The above product is exclusively intended to be installed into a machine or an incomplete machine. The said product does not yet conform to all the relevant requirements defined in the Directive on Machinery referred to above for this reason.

The specific technical documents listed in Appendix VII, Part B, have been prepared. The Authorized Agent empowered to compile technical documents may submit the relevant documents if such a request has been properly justified.

Commissioning of an incomplete machine must not only be carried out if it has been determined that the respective machine into which the incomplete machine is to be installed conforms to the regulations set out in the Directive on Machinery referred to above.

The above product conforms to the requirements of the directives and harmonized standards specified below:

- Directive 2014/68/EU
- EN ISO 12100 Safety of machinery

Knittlingen, 21.09.2017

i.V. Uwe Heisswolf
Head of Development

